

TURKISH ACOUSTIC



ACOUSTIC

C A T A L O G U E

APS

Compressed Fiberglass Acoustical Panels

TURCOCORE

PET Panels Acoustical Systems

TURCOWOOD

Wooden Panel Acoustical Systems

FILZ

Woollen Acoustical Systems Panels

3D

Acoustical Systems Panels





TURKISH ACOUSTIC

Acoustical Systems

Why Control Sound?

INCREASED AND BETTER AUDIBILITY:

A good acoustical sound absorption ceiling/panels will help to talk, converse at a lower tone and drain lesser energy with clear deliveries thus establishing clarity in communication.

REDUCES STRESS LEVELS:

A good acoustical sound absorption system helps in proper deflection of communication thereby reducing stress levels and contributing to better health conditions for all.

REDUCES NOISE POLLUTION: Good acoustical system in general, greatly reduces noise pollution and thus regulating body pressure. This, in turn, leads to higher output and energy levels.



TURKISH ACOUSTIC

APS

Compressed Fiberglass Acoustical Panels

Turkish APS Acoustical System is a world class product for acoustic. Turkish APS is a compressed fiberglass acoustical system. Turkish APS has a wide range of product which includes Wall Panels, Baffles, Clouds, Deco Clouds, Acoustic Separators, Ceilings etc. Thus, Turkish APS is a solution for most of the acoustic requirement for walls and ceilings. It is a green system as it contains 59% post-consumer recycled glass. Turkish APS is a world class product in its NRC functionality as its NRC ranges between 0.80 and 1.05 with its multiple thicknesses for multiple applications.

TURKISH APS MULTI

Turkish APS Multi is a hard COMPRESSED FIBERGLASS core Acoustical Panel. They function as noise reduction panels to absorb and reduce the noise levels within the area. All the edges are chemically hardened. The panels are wrapped with different kinds of coverings. Breathable coating can also be used on the surface.

- *Maximum dimensions: L-2.44m, W-1.22m,*
- *Thickness: 1" and 2",*
- *Weight Kg/ M² (+/- 10%): 1"= 2.98 and 2"=5.95*
- *Density: 6-7 PCF Compressed Fiber glass core*
- *Edges: Square/ Bevelled/ Mitre/ Radius*
- *Warranty: Warranty against workmanship and manufacturing defects for 2 years from date of purchase*
- *Fire Rating: Class "A" as per ASTM E-84 Tunnel Test*
- *Mounting Methods: Z Clip Attachments, Impaler Clip with Adhesive*

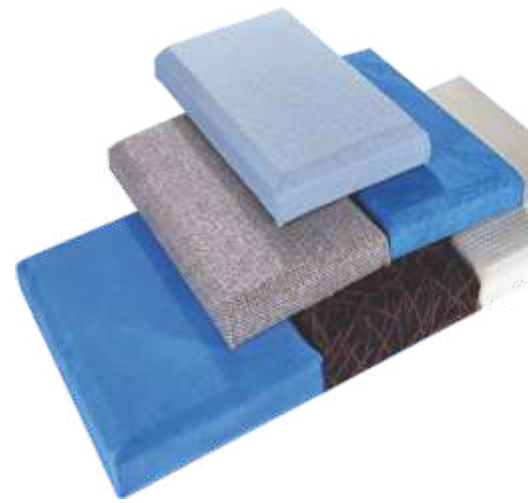

Performance- 1"								
Frequency	125	250	500	1000	2000	4000	NRC	R Value
Absorption coefficients	0.06	0.27	0.76	1.02	1.08	0.98	0.8	4.5
Performance- 2"								
Frequency	125	250	500	1000	2000	4000	NRC	R Value
Absorption coefficients	0.18	0.89	1.12	1.05	1.04	1.02	1.05	9

TURKISH ACOUSTIC

TURKISH APS TAC

Turkish APS TAC are made up of compressed fiber glass core. These Panels have high impact, high density fiber glass facing to safely hold tack pins for presentation and visual displays. They function as noise reduction panels to absorb and reduce the noise levels within the area. They are wrapped with different kinds of coverings.

- *Maximum dimensions: L-2.44m, W-1.22m,*
- *Thickness: 1.125" and 2.125",*
- *Weight Kg/ M² (+/- 10%): 1.125" = 3.84 and 2.125" = 6.81*
- *Density: 6-7 PCF Compressed Fiber glass base core*
- *Edges: Square/Bevelled/Mitre/Radius*
- *Warranty: Warrantied against workmanship and manufacturing defects for 2 years from date of purchase*
- *Fire Rating: Class "A" as per ASTM E-84 Tunnel Test*
- *Mounting Methods: Z Clip Attachments, Impaler Clip with Adhesive*

Performance- 1"								
Frequency	125	250	500	1000	2000	4000	NRC	R Value
Absorption coefficients	0.06	0.27	0.76	1.02	1.08	0.98	0.8	4.5
Performance- 2"								
Frequency	125	250	500	1000	2000	4000	NRC	R Value
Absorption coefficients	0.18	0.89	1.12	1.05	1.04	1.02	1.05	9

FABRIC COLORS - Aster

AMELIA

Available in
11 colours



VAM 02 Taffy



VAM 03 Caramel



VAM 04 Amaretto



VAM 05 Snickers



VAM 06 Toffee



VAM 07 Almond Roca

BASIX 60

Available in
48 colours



B60130 Wheat



B60150 Wedgewood



B60153 Baltic



B60175 Crystal Blue



B60238 Grey



B60298 Medium Grey

CATALYST

Available in
24 colours



VCA 01 Mint



VCA 02 Pewter



VCA 03 Sierra



VCA 04 Desert



VCA 05 Storm



VCA 06 Jade

COBBLE

Available in
10 colours



VCB 01 Pewter



VCB 02 Dune



VCB 03 Chamois



VCB 04 Baltic



VCB 05 Terra



VCB 06 Butterscotch

CREPE

Available in
36 colours



ACR 101 Crimson



ACR 102 Black

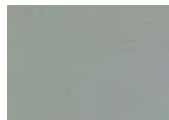

ACR 103 Lunar



ACR 104 Cinnamon



ACR 105 Spice



ACR 106 Hunter

ESSENCE

Available in
22 colours



VES 01 Avocado



VES 02 Seaside



VES 03 Waterfront



VES 04 Barley

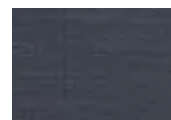

VES 05 Starlight



VES 06 Tabasco

FLOATATION

Available in
13 colours

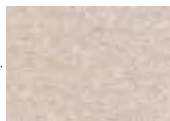

VFL 01 Neat

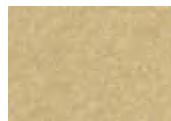

VFL 02 Sour

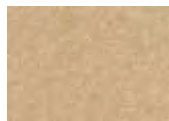

VFL 03 Sweet



VFL 04 Liqueur

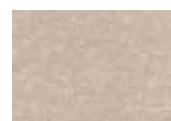

VFL 05 Bitters

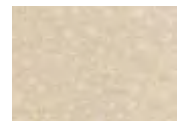

VFL 06 Seltzer

ILLUSIONS

Available in
12 colours



VIL 01 Lake



VIL 02 Vintage



VIL 03 Starry



VIL 04 Limeade

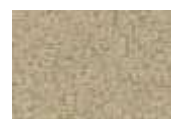

VIL 05 Moss



VIL 06 Gravel

TURKISH ACOUSTIC

INFUSED

Available in
17 colours

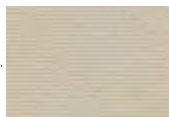

VIF 01 Moonstone



VIF 02 Platinum

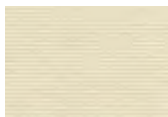

VIF 03 Bisque

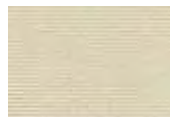

VIF 05 Beach

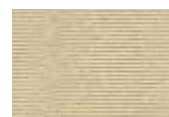

VIF 06 Sprout



VIF 07 Angora

MESH

Available in
12 colours



*PFM 178 Lacquered
Bronze*



*PFM 179 Etched
Bronze*

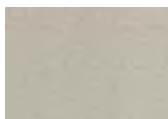

PFM 181 Chrome

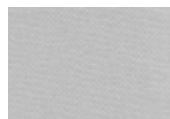

*PFM 182 Stainless
Steel*



PFM 183 Dark Anneal

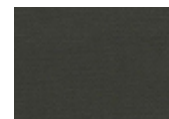

PFM 184 Stove Pipe

MULTI TWIST

Available in
16 colours



VMT 01 Spice

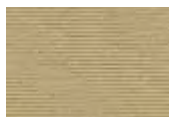

VMT 02 Safari



VMT 03 Rye



VMT 04 Graphite



VMT 05 Cayman



VMT 06 Dew

REED

Available in
10 colours



ARE 201 Cypress



ARE 202 Liberty



ARE 203 Dakota



ARE 204 Brick

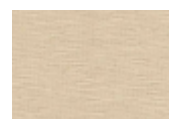

ARE 205 Gladestone



ARE 206 Tusk

RESOLUTION

Available in
17 colours

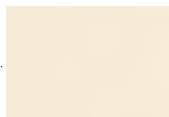

VRE 01 Pearl

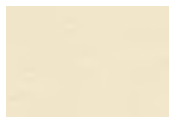

VRE 02 Bisque

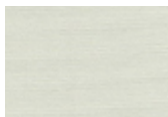

VRE 03 Sea Mist



VRE 04 Cloud

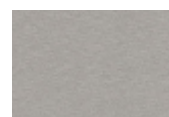

VRE 05 Sterling

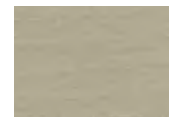

VRE 06 Celery

SEAPORT

Available in
17 colours



VSE 01 Moonlight



VSE 02 Seaweed



VSE 03 Coral



VSE 04 Tide



VSE 05 Crest

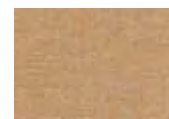

VSE 06 Sunset

SNOOPY

Available in
57 colours



Amethyst



Blueberry



Avocado



Cherry



Dijon



Jade

STRIATA

Available in
6 colours



VST 01 Sahara



VST 02 Mojave



VST 03 Sunray

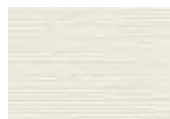

VST 04 Oyster



VST 06 Moonbeam



VST 08 Bluejay

TUSCANY

Available in
12 colours

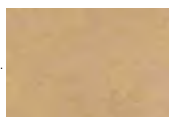

VTU 01 Pecan



VTU 02 Azure

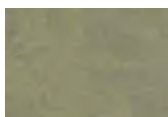

VTU 03 Bayberry

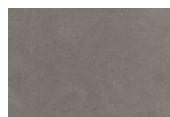

VTU 04 Graphite

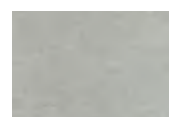

VTU 05 Willow



VTU 06 Parchment

FABRIC COLORS - Clover

DIAMOND

Available in
6 colours



DD 01



DD 02



DD 03



DD 04



DD 05



DD 06

FESTIVAL

Available in
46 colours



F 92



F 102



F 103



F 107



F 108



F 112

LINEN

Available in
11 colours



LN 01



LN 02



LN 03



LN 04

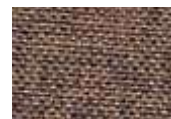

LN 05



LN 06

MARS

Available in
51 colours



MS 401



MS 402



MS 403



MS 404



MS 405



MS 406

MARS - 2

Available in
30 colours



MS 2009



MS 2010



MS 2011



MS 2012



MS 2013



MS 2015

MODERN

Available in
20 colours

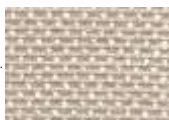

MN 01

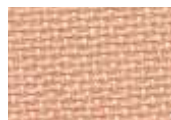

MN 02



MN 03



MN 04



MN 05

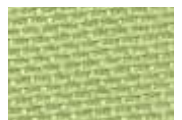

MN 06

SANDUNE

Available in
16 colours



SD 102



SD 103



SD 116



SD 128



SD 151



SD 161

SPIRAL

Available in
11 colours



SP05 03



Sp05 05



Sp05 07



Sp05 09



Sp05 11



Sp05 12

TURKISH ACOUSTIC

TITAN

Available in
5 colours



TN 01



TN 02



TN 03



TN 04



TN 05

VIBRANT

Available in
33 colours



V 316



V 330



V 333



V 1001



V 1002



V 1003

VINTAGE

Available in
21 colours



VG 01



VG 02

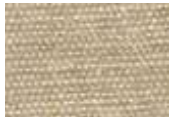

VG 03



VG 04



VG 05



VG 06

VINYL COLORS



PLS 050 Ruby



PLS 049 Pinot



PLS 041 Tan



PLS 042 Forest



PLS 043 Everglade



PLS 044 Whisper



PLS 045 Mesa



PLS 046 Wave



PLS 047 Midnight Blue



PLS 048 Sedona



PLS 033 Shale



PLS 034 Skylar



PLS 035 Coal



PLS 036 Warm Dawn



PLS 031 Sunshine



PLS 032 Mascot



PLS 034 Skylar



PLS 035 Coal



PLS 025 Blitzed



PLS 026 Cloud



PLS 027 Portland



PLS 028 Soledad



PLS 029 Devlin



PLS 030 Coco



PLS 031 Sunshine



PLS 032 Mascot



PLS 017 Blind Side

Available in
50 colours

APS *Compressed Fiberglass Acoustical Panels*

APPLICATIONS



TURKISH ACOUSTIC



TURKISH APS Baffles

The sound baffles are all designed for ceiling suspension in loud venues that require a reduction in echo to produce more favourable room acoustics. Turkish APS Baffles are generally used in large open areas that have minimal wall surfaces to attaché traditional wall panes. These are hanged vertically from the ceiling. They come with chemically impregnated bolt for hanging. Helps in eliminating echoes & reduction in reverberation time. It also controls and reduces problem caused by air borne noise.

Turkish APS Baffles are wrapped with Perforated Vinyl or Fabric.

- *Thickness: 1" to 2.25"*
- *Edges: Square*
- *NRC: Upto 1.05*
- *Colors: Almost 60 different colors of perforated vinyl*
- *Weight Kg/M² (+/- 10%): 7.65*
- *Warranty: Warrantied against workmanship and manufacturing defects for 2 years from date of purchase*
- *Fire Rating: Class "A" as per ASTM E-84 Tunnel Test*
- *Dimensions : Any size within L-2.44m & W-1.22m.*

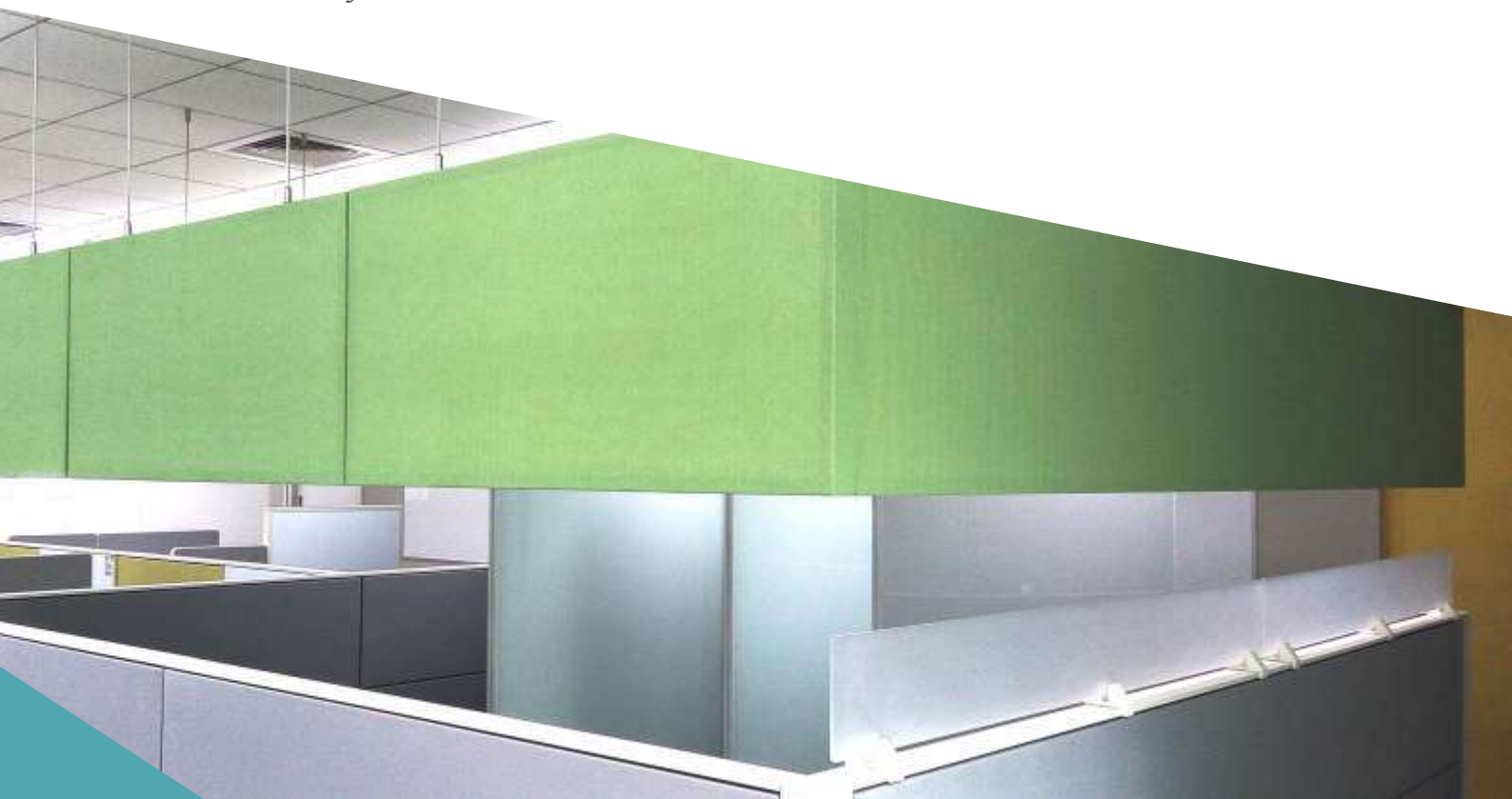

TURKISH ACOUSTIC

TURKISH APS CLOUDS

Acoustic Clouds prevent sound from bouncing around a room - like in a noisy restaurant or hall - by absorbing unwanted sound waves and reducing reverberation times. Turkish APS Clouds are generally used in large open areas that have minimal wall surfaces to attaché traditional wall panes.. These are hanged horizontally to the ceiling. They come with chemically impregnated bolts for hanging. Clouds controls and reduces problem caused by air borne noise.

Turkish APS Clouds are wrapped with Perforated Vinyl or Fabric.

- *Thickness: 1” to 2.25”*
- *Edges: Square*
- *NRC: Upto 1.05*
- *Colors: Almost 60 different colors of perforated vinyl*
- *Weight Kg/M²(+/- 10%): 2.98 to 7.65*
- *Warranty: Warrantied against workmanship and manufacturing defects for 2 years from date of purchase*
- *Fire Rating: Class “A” as per ASTM E-84 Tunnel Test*
- *Dimensions: Any size within L-2.44m & W-1.22m.*



APS *Deco Clouds & Baffles*

Turkish APS DECO CLOUDS & BAFFLES are flat, compressed fibreglass panels. These panels are decorative sound absorption available in standard shapes and custom shapes. These panels are painted panels and can be painted in most of the custom colors. Deco Clouds & Baffles are easy to install due to its modular accessories. These can be easily installed with very easy adaptation to various heights and angles. In case of clouds, some special accessories helps to group the panels together for cloud formation.

SPECIFICATION

- Thickness: 28 / 30 / 53 / 55 mm
- Core: Compressed Fiberglass Core
- Clouds Size: 1200 / 900 / 600 mm X 1200 / 900 / 600 mm
- Baffles Size: L-600 to 2400 mm, H-150 to 1200 mm
- Weight Kg/ m² (+/- 10%): 2.98 to 7.65
- Core: Compressed Fiber glass core
- Edges: Square
- Warranty: Warranty against workmanship and manufacturing defects for 2 years from date of purchase
- Fire Rating: Class 'A' as per ASTM E-84 Tunnel Test
- NRC: Upto 1.05



CLOUDS PATTERNS

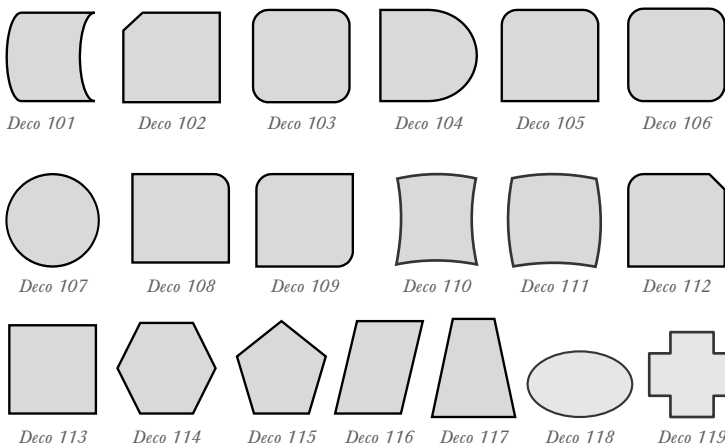

BAFFLES PATTERNS

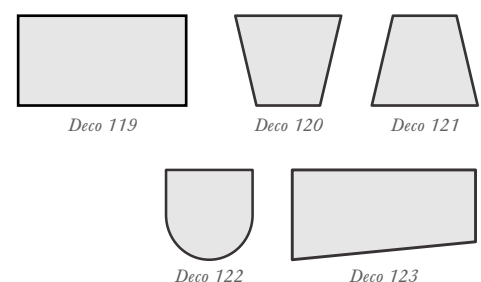

Turkish APS Ceiling is a compressed fibreglass ceiling available in multiple sizes, patterns, edges and colors. It has remarkable advantages v.i.z. non-combustible, no sagging, no warping, no de-lamination, excellent sound absorption, & choice of different patterns.

- DESCRIPTION
- Material: Compressed high density fiberglass wool
- Face: Special painting laminated with decorative fiberglass tissue
- Color: White, black and others to order
- Fire-resistant: Class A, non-combustible.
- Thermal-Resistant: $0.4 (m^2 k/w)$
- Humidity: Dimensionally stable with RH up to 95% at 40°C.
- Moisture rate: 1%(JC/ T670-2005)
- Environmental impact: Tiles and packings are fully recyclable.

SPECIFICATION

- Thickness: 12mm, 15mm, 20mm, 25mm
- Size: 600 x 600mm, 600 x 1200mm.
Customized sizes are available.
- Density: 80 - 150 Kg/ m³
- NRC: Upto 1.05

EDGE TYPES:

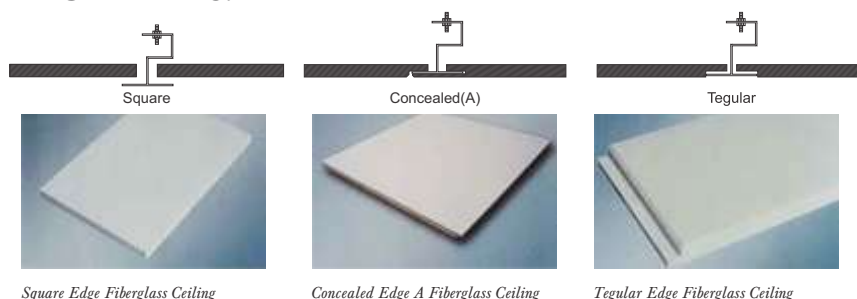

APS *Compressed Fiberglass Acoustical Panels*

WHY TRANQUIL APS?

- The product is manufactured in an ultra modern plant in America
- Up to 60% of the material to produce glass wool are recycled
- The product meets international standards of ASTM - E - 84 / ASTM - E - 1264
- A safe fire retardant product which generates non- toxic smoke.
- The product meets standards of ASTM C 423 for NRC.
- No carcinogenic material. According to assessments by entities such as OSHA, EPA, IARC
- and NAIMA, Turkish APS do not cause cancer.

Products are anti bacterial, mold / moisture resistant



T & C Apply

All products are class A fire rated as per
ASTM - E - 84 & ASTM E - 1264



Turkish APS Separators is a medium density hard compressed fiberglass core used as separators in workstations. They function as noise reduction panels to absorb and reduce the noise levels within the area. All the edges are chemically hardened with/without aluminium profile. The panels can be wrapped with different kinds of coverings.

SPECIFICATION

- *Thickness: 25mm,30mm,50mm,56mm or customised to requirement*
- *Weight Kg/ m² (+/- 10%): 2.95 to 4.60*
- *Core: Compressed Fiber glass core*
- *Size: Custom Size can be manufactured.*
- *Edges: Chemically hardened or Aluminum Profile*
- *Warranty: Warranty against workmanship and manufacturing defects for 2 years from the date of purchase*
- *Fire Rating: Class 'A' as per ASTM E-84 Tunnel Test*
- *NRC: Upto 1.05*

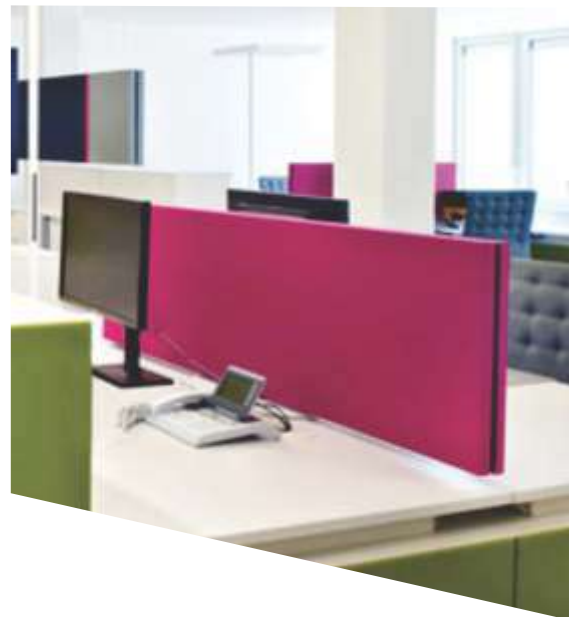

ACOUSTIC SCREENS

Turkish APS Screens are Noise Reduction Partitions made of medium density hard compressed fiberglass core. It is used as decorative modular screens in spaces with noise problem and requires a partition. All the edges are chemically hardened and fixed within aluminium profile. The panels can be wrapped with different kinds of coverings including Fabric and Vinyl.

SPECIFICATION

- *Thickness: 25mm,30mm,50mm,56mm or customised to requirement*
- *Weight Kg/ m² (+/- 10%): 2.95 to 4.60*
- *Core: Compressed Fiber glass core*
- *Size: Custom Size can be manufactured.*
- *Edges: Aluminum Profile*
- *Warranty: Warranty against workmanship and manufacturing defects for 2 years from the date of purchase*
- *Fire Rating: Class 'A' as per ASTM E-84 Tunnel Test*
- *NRC: Upto 1.05*







TURKISH ACOUSTIC

TURCOWOOD

Wooden Panel Acoustical Systems

For world-class sound absorption & reverberation control, Turkish Turcwood Wooden panels offer the best solution. These panels are a wide range of perforated, grooved wooden wall & ceiling panels. These are available in a standard range of veneers and laminate surfaces. Their design is durable and offer invisible interlocking and concealed fixing systems to ensure a seamless fit.

TURCOWOOD *Wooden Panel Acoustical Systems*

FEATURES

- Excellent Sound Absorption & Reverberation Control
- Fire Rated & Low Formaldehyde
- High Impact & Durable
- Black Felt Backing
- Invisible Interlocking & Concealed Fixing System

FIXING DETAILS

Linear Grooved Panels

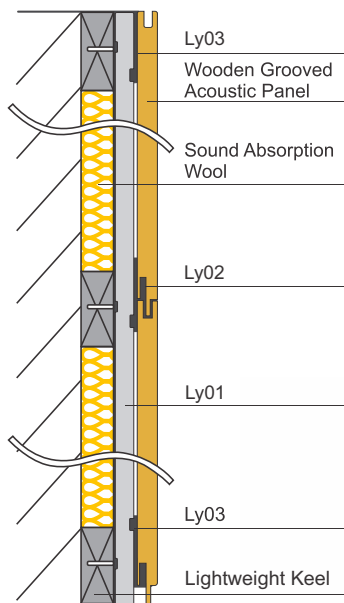

Cross-section Structure

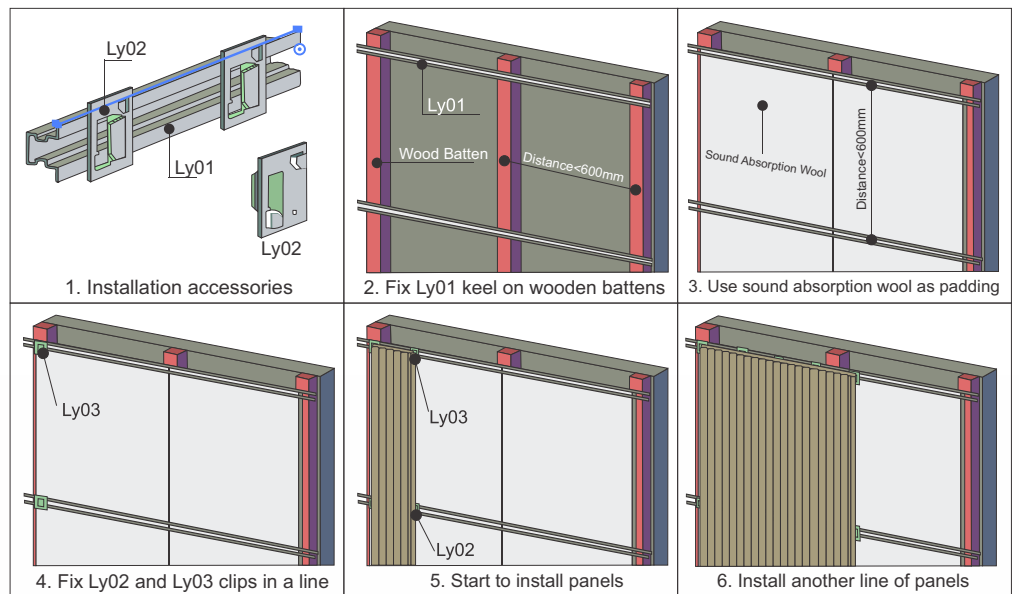

Installation: Lightweight Steel Keel System

Perforated Tiles

Installation System I (with gap)

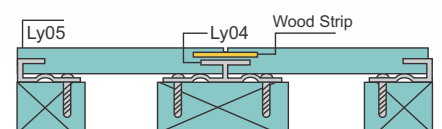
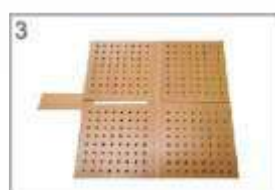

Cross-section Structure

Installation System II (without gap)

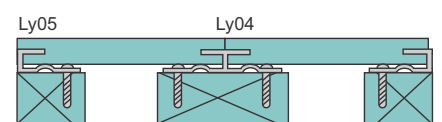

Cross-section Structure

ABSORPTION COEFFICIENT

TURKISH ACOUSTIC

Absorption Coefficient

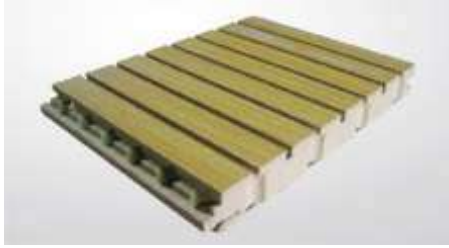

Pattern 13-3

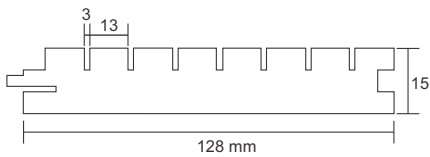

(Pattern 13-12) Perforation Rate:12%

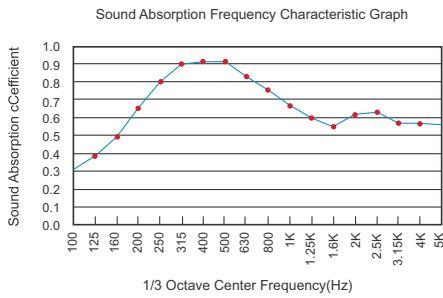

Pattern 14-2

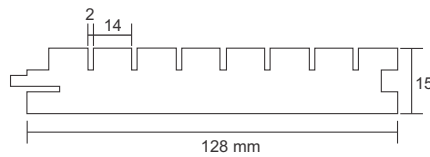

(Pattern 14-2) Perforation Rate:7.5%

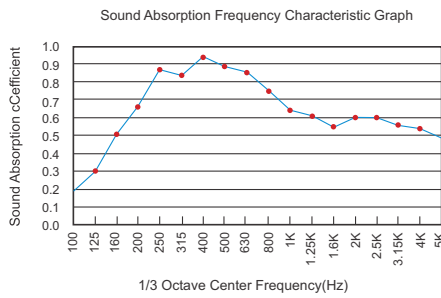

Pattern 28-4

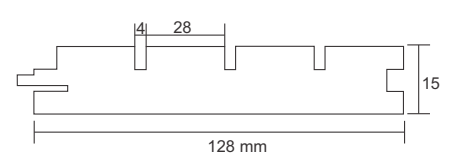

(Pattern 28-4) Perforation Rate:7%

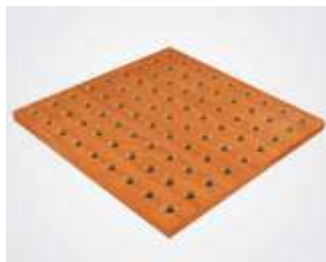
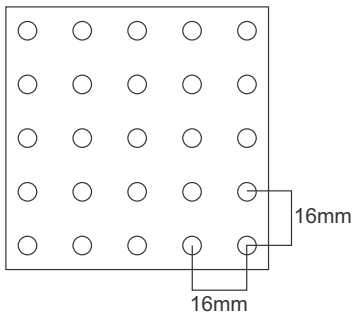
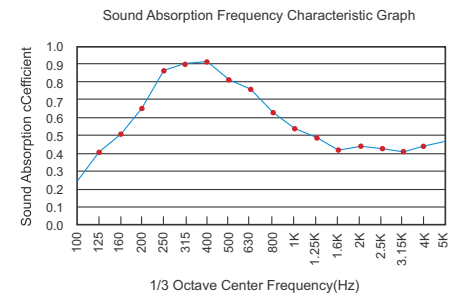

Pattern:16-16-6

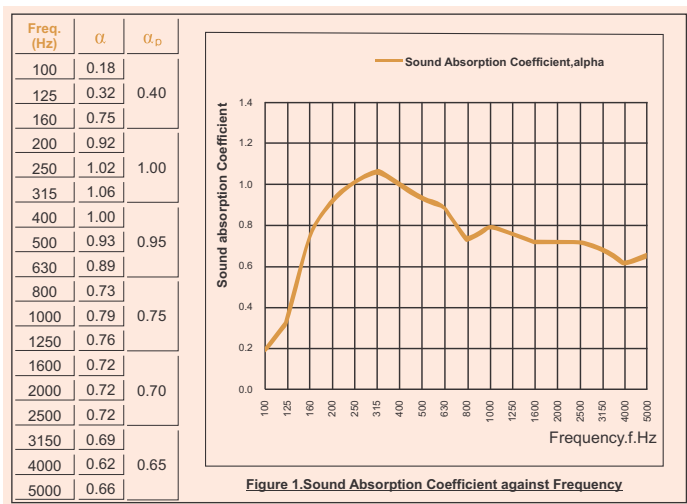
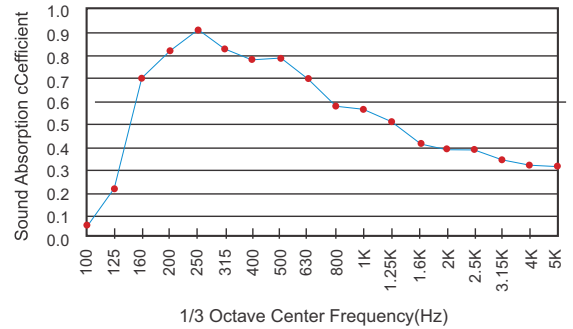

Linear Groove 13-3: NRC of 0.86 with Acoustic backing & Gap of 100mm.

TURCOWOOD *Wooden Panel Acoustical Systems*

APPLICATIONS



TURKISH ACOUSTIC



COLOR PATTERNS

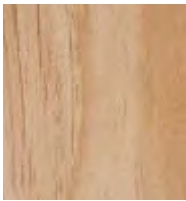

TREW 006 Elegant Walnut



TREW 007 Oak White



TREW 011 Light Cherry

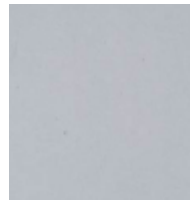

TREW 012 Frosty Grey

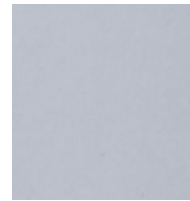

TREW 014 Arctic White



TREW 015 Bliss Walnut



TREW 019 Tuscany Walnut



TREW 020 Maple



TREW 025 Brazilian Cherry

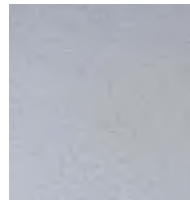

TREW 026 Silver Grey

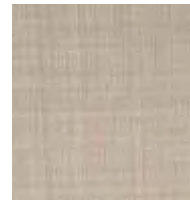

TREW 027 Cognac

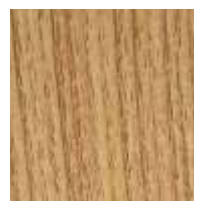

TREW 028 Portland Oak



TREW 035 Dark Brazilian Cherry



TREW 042 Plateau Teak



TREW 043 Merbau



TREW 045 Dark Oak

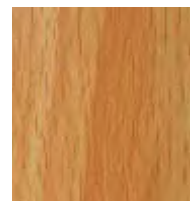

TREW 046 Atlas Cherry



TREW 048 Beech



TREW 052 Borneo Teak



TREW 101 Bright White

TURCOWOOD *Wooden Panel Acoustical Systems*

DESIGN PATTERNS

CUSTOM DESIGNS



CS 1001



CS 1002



CS 1003



CS 1004



CS 1005



CS 1006



CS 1007



CS 1008



CS 1009



CS 1010



CS 1011



CS 1012



CS 1013



CS 10014



S56D Slots



S56 Slots



S32 Square



SI100 Slots Offset

PERFORATED



P616D Holes

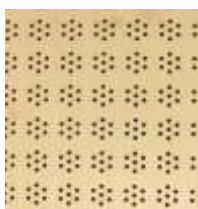

Pf3 Holes



P616 Holes



P416 Holes



P816 Holes



P932 Holes



Pf1 Holes



P316 Holes



Pf05

TURKISH ACOUSTIC

DIFFUSERS



1D Diffuser



2D Diffuser



3D Pyramid Diffuser



Diffuser 36



Diffuser 101



Diffuser 104



Diffuser-J10



Diffuser 6020



Diffuser-DF-30



Diffuser 105



Diffuser 106



Diffuser-6T



Pyramid



Radius

LINEAR



Grooves 168



Grooves 324



Grooves 816





TURKISH ACOUSTIC

FILZ

Woollen Acoustical Systems Panels

A product with world-class versatility and variety, Turkish FILZ carries 100% Wool Panels in almost 63 colors and five thicknesses. Using wool ensures durability, dye ability, resistance to flame and compression, and thermal and sound insulation.

The material is 100% bio-degradable and rapidly renewable thus guaranteeing environmental sustainability.

CHARACTERISTICS THAT INCLUDE:

The FILZ is non-directional, has no right side or wrong side, and the color is consistent throughout

- The widths can be up to 180 cm (70 3/4 in)
- Highly saturated colors that are lightfast
- Naturally repels soiling and moisture
- Since it's a nonwoven, it can be cut with the edges left raw. No fraying!
- The thickness and density also give it a structural quality that allow for hanging installations that do not require any additional support
- Self-extinguishing and inherently flame retardant
- Thermal and acoustic insulating properties
- Eco-friendly

FILZ COLORS

MELANGE COLORS



102 Kirche



105 Rost



116 Orange



125 Tomate



136 Weinrot



156 Loden



203 Vanille



274 Senf



312 Lagune



319 Café



331 Sahara



385 Schlamm



408 Taupe



415 Schlif



437 Aubergine



448 Moos



503 Magnolie



534 Rose



540 Ozean



613 Gletscher



626 Azur



686 Enzian



713 Kiwi



732 Farn

TURKISH ACOUSTIC

NATURAL COLORS



100 Wollweib



110 Rohweib



150 Weib



160 Beige



170 Asche



175 Graphite



200 Natur



220 Rahbraun



250 Truffelbraun



300 Anthrazit

UNI COLORS



124 Gelb



131 Honig



151 Hellorange



173 Mango



179 Hellrot



180 Terracotta



201 Rot



209 Bordeaux



231 Rosa



242 Pink



255 Flieder

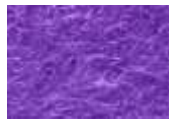

265 Lavendel



269 Violett



272 Royal



282 D'Blau



284 Himmel



286 H'Blau



308 Petrol



343 D'Grun



377 Maigrun



378 Oliv



384 Lind



423 Hellgrau



425 Taubengrau



426 Schwarz



467 Sand



476 Schoko



497 D'Braun



548 Turkis

FILZ *Woollen Acoustical Systems Panels*

AKUSTIKA WALL

- Akustika Wall is a wall-mounted acoustic system with 3mm Wool Design Filz flush-mounted to one side or 2mm Design Filz wrapped around an ultra-thin acoustic substrate.
- Available in customizable sizes in 63 colors.
- Akustika Wall achieves up to a 0.75 Noise Reduction.



TURKISH ACOUSTIC

TURKISH FILZ CLOUDS

- TURKISH FILZ CLOUDS is a collection of acoustic solutions that effectively (and beautifully) abate sound reverberation.
 - Available in almost 63 colors of 3mm Wool Design Filz or 33 colors of 2mm Wool Design Filz.
 - TURKISH FILZ CLOUDS is Suspended with standard suspension hardware that allows for easy installation.
-
- *THICKNESS: 28mm and 31mm*
 - *NRC: 0.75*

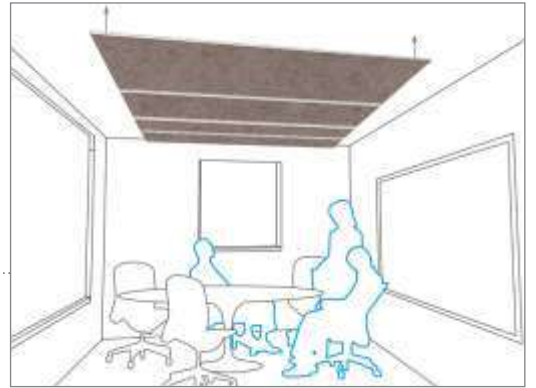

TURKISH FILZ BAFFLE

- Turkish Filz Baffle is a suspended panel oriented perpendicular to the ceiling to optimize sound absorption.
 - This smart acoustic solution creates subtle patterning across the ceiling in 63 colors and provides almost 1.00 Noise.
-
- *THICKNESS: 28mm and 31mm*
 - *NRC: 0.75*

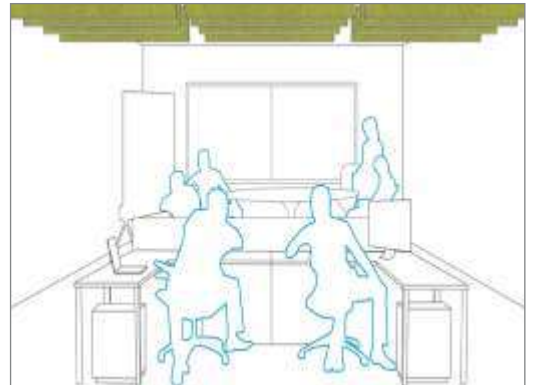

FOLDING CLOUD

- Turkish Filz Folding Cloud offers a surface-mounted acoustic solution that can softly fade into the background or create an unexpected pop of color and texture.
- Turkish Filz Cloud is available with the Interlock Mounting System that allows for a quick and easy installation, even in an occupied space.



HANGING PANELS

- Sweeping movement across multiple panels, which is created from horizontally transforming parallelograms.
- Hanging panels add texture, color, and modulated visibility to any space.
- It offers standard static and transforming patterns that can be used individually or in series.
- The panels define space, control light and view, and provide varied degrees of privacy.
- Available in 43 colors of 5mm Wool Design Filz, these hanging panels are compatible with Hanging Panel Track System.
- Wool Filz is the ideal choice for hanging panels due to its softness and texture plus thickness and density that allow the panels to hang freely without a backing or additional support.
- Since Wool Design Filz is a non-woven textile, intricate cut-out patterning can be achieved without the need for finishing the edges.
- This enables a modern screening system created simply by cutting away material and cannot be achieved with any other natural material.
- Available in 43 colors of 5mm Wool Design Filz.

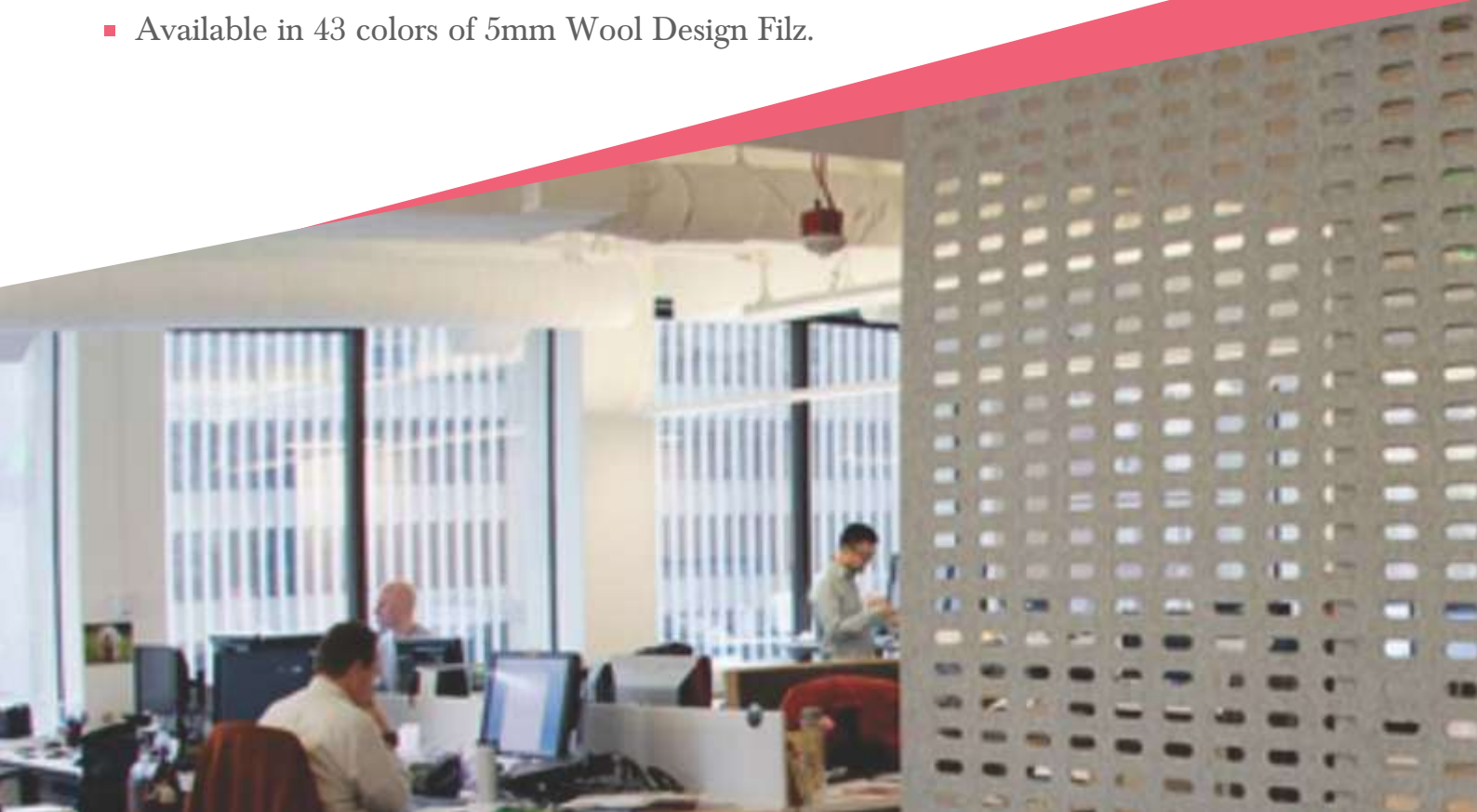

TURKISH ACOUSTIC

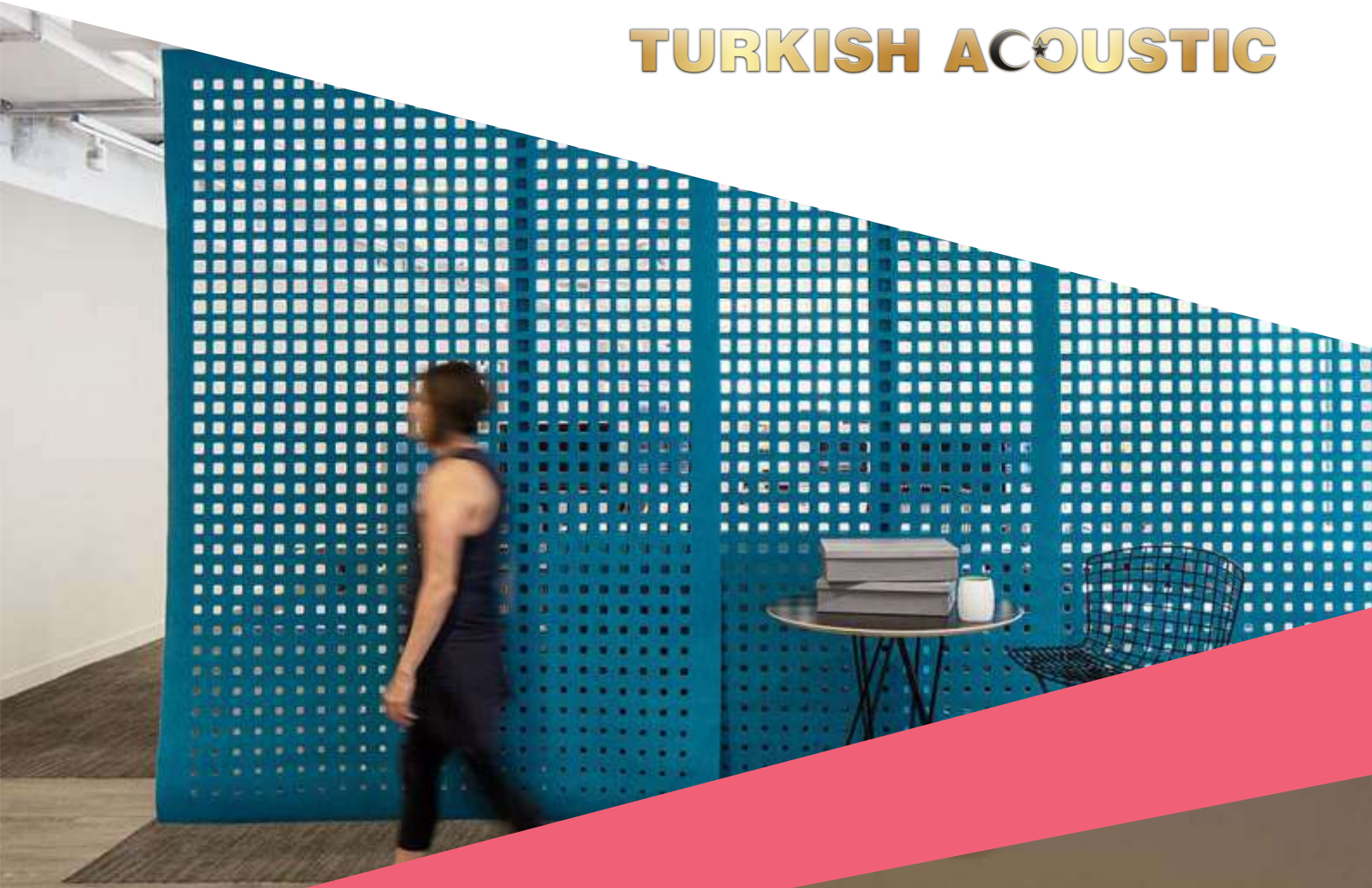

PANNELLO MURALE

- Hung on the wall, Pannello Murale is space efficient and highly effective, as it absorbs sound on both sides and does triple duty as a sophisticated projection screen and tackable surface.
- This elegant panel is created with an aluminum frame that gracefully tapers to a thin profile masking a high performing sound-absorbing core of Turco Core and exterior covered in flush-mounted 100% Wool Design Filz.
- The Pannello Murale provides a beautiful, yet hard-working acoustic panel.
- Available in four standard sizes and 63 colors of 3mm Wool Design Filz.



PANNELLO SEMPLICE

- Murale's straight-laced cousin, Pannello Semplice is a wall-mounted panel available in two standard sizes with custom sizes available.
- The innovative aluminum frame places the acoustic material at an optimum 10 cm (4 in) away from the wall, maximizing acoustic absorption.
- In addition, this versatile panel system can go wall-to-wall, wrap a 90-degree corner.
- Like its Pannello counterparts, Semplice also provides a sophisticated projection or tack surface.
- Available in two standard sizes and 63 colors of 3mm Wool Design Filz.



PANNELLO PARAVENT

- Pannello Paravent beautifully answers the need for temporary privacy in an open space. This panel creates an informal division at a moments notice then can be folded flat to store with a minimal footprint.
- Designed for use as a movable room partition, each panel stands on two legs and can be minimized or enlarged at the user's discretion.
- Offered in three components, Left, Linking, and Right and two standard widths, this screen is available in 63 colors of 3mm Wool Design Filz.



TURKISH ACOUSTIC

PANNELLO SUSPENSO



PANNELLO TAVOLA

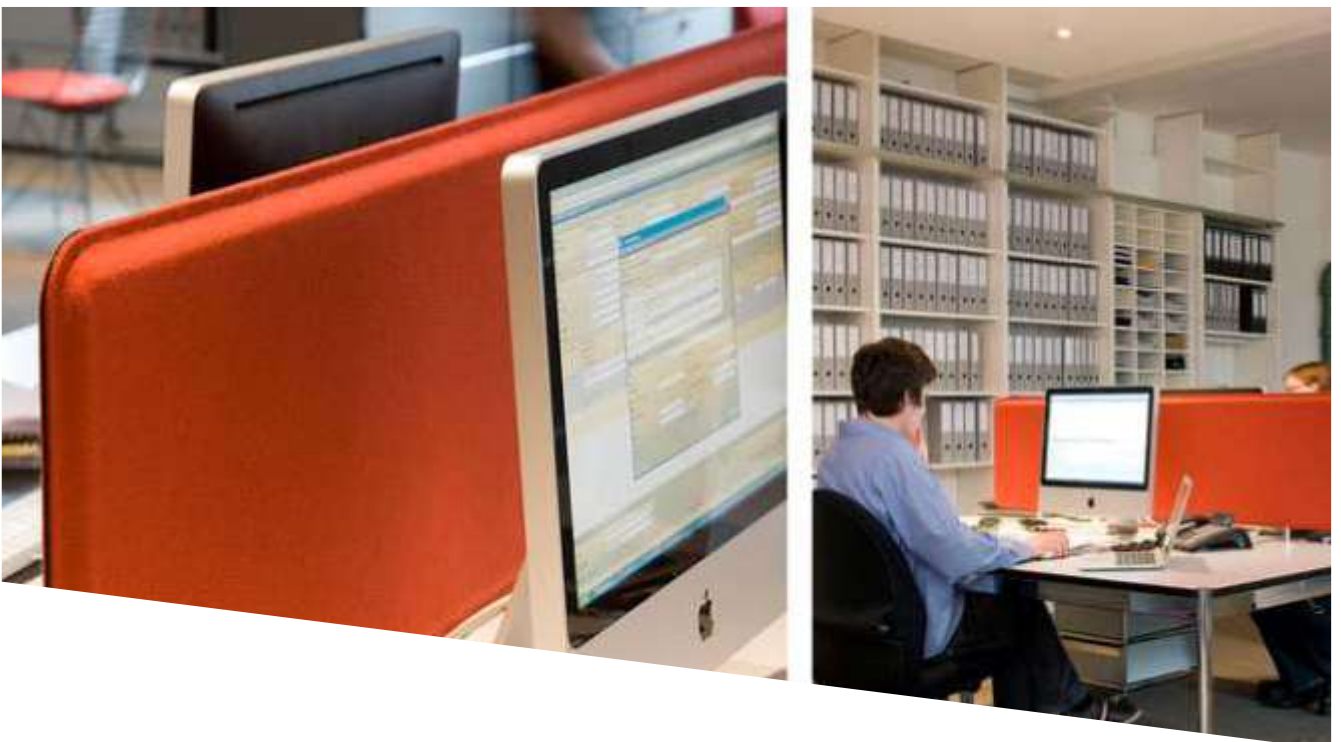



TURKISH ACOUSTIC

3D

Acoustical Systems Panels

Turkish 3D Panels is a range of 3d Designer Acoustic panels. These are one of the best design led acoustic panels which makes an area lively along with desired acoustic performance. These panels are easy to install and highly decorative. These panels come in standard sizes and standard designs with an option of almost 24 different colors. The designs provided can also be customized depending on requirement. The panels are highly versatile and can be combined with other acoustic materials in different ways to meet the needs of almost any room or environment. These are one of the best panels that can be used for areas where you need absorptive panels with great looks.

3D *Acoustical Systems Panels*

FEATURES

- Excellent Aesthetic Value
- Excellent Sound Absorption
- Fire Rated
- Can be used with acoustic filler to enhance absorption
- Comes in Multiple Colors



TURKISH ACOUSTIC



3D *Acoustical Systems Panels*

COLORS



TREC 05 Saffron

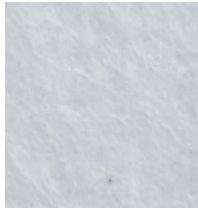

TREC 07 Arctic White



TREC 08 Fiery Red



TREC 11 Silver Grey



TREC 13 Black

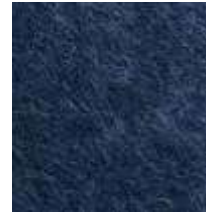

TREC 19 Indigo



TREC 24 Cherry



TREC 25 China Sea



TREC 28 Sun



TREC 35 Caramel



TREC 37 Gungrey



TREC 39 Coffee



TREC 41 Cinnamon



TREC 43 Apple Green



TREC 44 Shimmer



TREC 46 Orange



TREC 49 Purple



TREC 51 Emerald



TREC 71 Peacock Blue



TREC 71 Pulp Pink

SPECIFICATIONS

Size(standard)	600*600*74mm / 500*500*60mm
Surface Finish	Matt
Weight	0.45-0.65 kg /piece
NRC	0.60 to 0.95
Indoor/Outdoor	Indoor only
Fire Rating	Euro class B and ASTM E84-08
Refinish able	No
Care Instructions	Remove spills immediately using damp & clean cloth. Carpet & Fabric Cleaners can be used. Always test a sample before applying on total surface.
ENV Information	Oeko-Tex 100 acquired
Flame Spread	25
Smoke Density	300
Fire Class	A

TURKISH ACOUSTIC

DESIGNS



Arc 004B



Arc Diagonal 003B



Board 001A

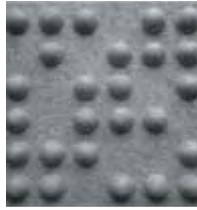

Code 014E



Crater 007C



High Waves 017E



Leaves 009E



Light 018E

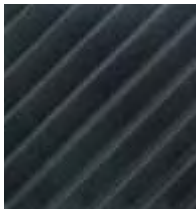

Oblique 005



Pyramid 016E



Seashell 013



Shadow 015E



Square 3D 011E



Twig 006B



Wave 010E



Weave 002



Ball 025A



Cube 022A



Cupoid 027E



Floral 023A



Hour Glass 026A



Mountain 021A



Pan 028E

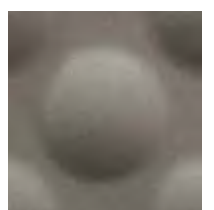

Spheres 028E

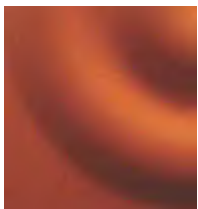

Spiral 029E



Square Whirl 024A





TURKISH ACOUSTIC

TURCOCORE

PET Panels Acoustical Systems

A durable and versatile product, Turkish Turcocore is made of 100% PET fiber. It is bonded using heat, instead of traditional chemical binders which ensures that it is naturally resistant to fire, moisture, vermin, insects, mould and bacteria. These world-class panels not only serve as acoustic panels but also as thermal insulations. They are so versatile that they can be used as bare panels if required. Turkish Turcocore also has a range of BAFFLES & CLOUDS. Turkish Turcocore Baffles & Clouds are generally used in large open areas. They come with impregnated bolts used for hanging them vertically or horizontally from the ceiling.

TURCO CORE *PET Panels Acoustical Systems*

SPECIFICATION

- Thickness: 9mm, 12mm and 25mm
- Maximum dimensions: L-2.44m, W-1.22m
- Density Kg / m³ (+/- 10%): 12mm-150 and 25mm-120
- 100% Polyester Core
- Edges : Square / Bevelled/ Mitre
- Warranty: Warranted against workmanship and manufacturing defects for 2 years from date of purchase
- Fire Rating: Class “A” as per ASTM E - 84 Tunnel Test
- Mounting Method: Glued to the wall with or without air gap using adhesive.

Performance (Without Gap) - 9mm							
Frequency	125	250	500	1000	2000	4000	NRC
Absorption co-efficients	0.05	0.07	0.12	0.35	0.68	0.56	0.30
Performance (Without Gap) - 12mm							
Frequency	125	250	500	1000	2000	4000	NRC
Absorption co-efficients	0.01	0.07	0.26	0.54	0.78	0.94	0.40
Performance (Without Gap) - 25mm							
Frequency	125	250	500	1000	2000	4000	NRC
Absorption co-efficients	0.07	0.28	0.63	0.87	0.99	0.98	0.70

TURKISH ACOUSTIC

TURCOCORE COLORS



TREC 01 Navy Blue



TREC 02 Soft Red

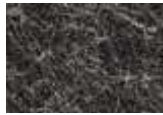

TREC 03 Greystone



TREC 04 Camel



TREC 05 Saffron



TREC 06 Mink



TREC 07 Arctic White



TREC 08 Fiery Red



TREC 09 Dolphin



TREC 10 Grass Green



TREC 11 Silver Grey



TREC 12 Pearl



TREC 13 Black



TREC 14 Light Blue



TREC 17 Dark Green



TREC 18 Pink



TREC 19 Indigo



TREC 21 Brownish Green



TREC 24 Cherry



TREC 25 China Sea



TREC 26 Celadon



TREC 28 Sun



TREC 29 Med Blue



TREC 30 Light Purple



TREC 31 Walnut



TREC 32 Light Brown

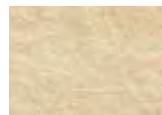

TREC 33 Garlic



TREC 34 Fawn



TREC 35 Caramel



TREC 36 Moonlight Grey



TREC 37 Gungrey



TREC 38 Ruite



TREC 39 Coffee



TREC 40 Salmon



TREC 41 Cinnamon



TREC 43 Apple Green



TREC 44 Shimmer



TREC 45 Acorn



TREC 46 Orange



TREC 47 Twister



TREC 48 Wine



TREC 49 Purple



TREC 50 Amethyst



TREC 51 Emerald



TURCO CORE *PET Panels Acoustical Systems*

APPLICATIONS

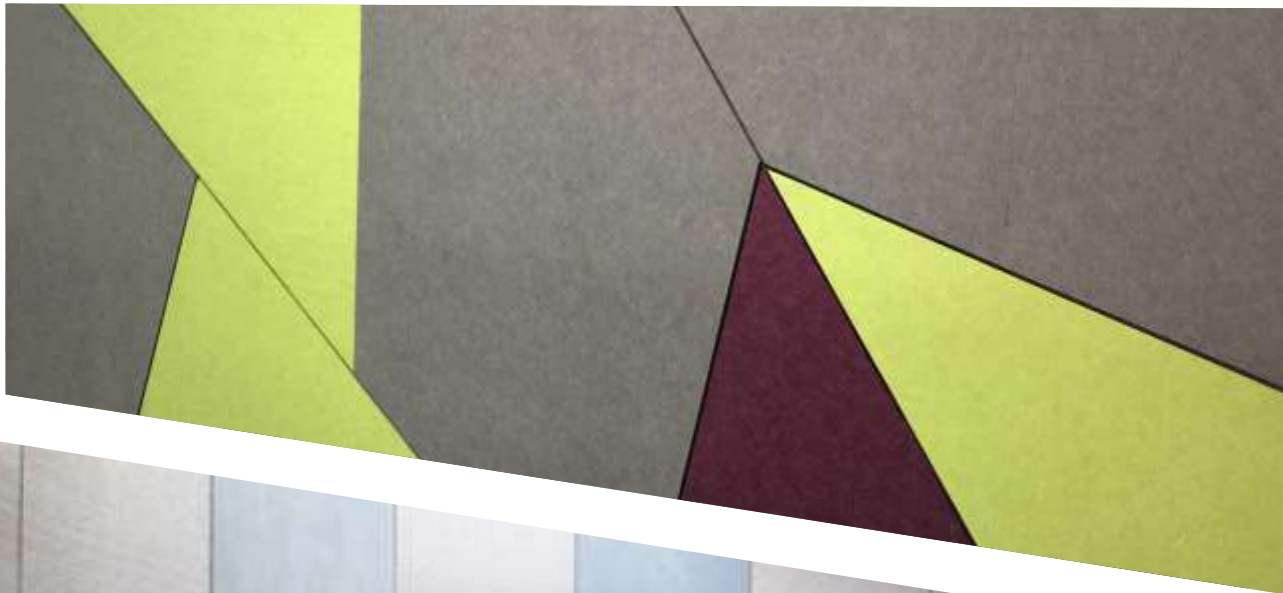

TURCOCORE *Printed*

Turkish Turcocore Printed are aesthetically designed printed Turcocore panels. These panels are available in 9mm, 12mm and 25mm. Turkish Turcocore Printed Panels gives you wide options of designs with the option of customization of designs to your requirement.

TURCOCORE PRINTED DESIGNS



Turco 1007



Turco 1031



Turco 1034



Turco 1036



Turco 1040



Turco 1042



Turco 1044



Turco 1045



Turco 1047



Turco 1048



Turco 1049



Turco 1123

PRINTED ECOCORE INSTALLED IMAGES



TURCOCORE

PET Panels Acoustical Systems

TURKISH TURCOCORE BAFFLES

Turkish Turcocore Baffles are generally used in large open areas that have minimal wall surfaces to attaché traditional wall panes. These are hanged vertically from the ceiling. They come with impregnated bolts for hanging.

Helps in eliminating echoes & reduction in reverberation time. It also controls and reduces problem caused by air borne noise.

- *Thickness - 28mm/31mm/50mm*
- *NRC - upto 0.95*



T & C Apply



TURKISH ACOUSTIC

TURKISH TURCOCORE CLOUDS

Turkish Turcocore Clouds are generally used in large open areas that have minimal wall surfaces to attaché traditional wall panes. These are hanged horizontally to the ceiling. They come with impregnated bolts for hanging.

Helps in eliminating echoes & reduction in reverberation time. It also controls and reduces problem caused by air borne noise.

- *Thickness - 28mm/31mm/50mm*
- *NRC - upto 0.95*

All products are Class A fire rated as per
ASTM - E - 84 & ASTM - E - 1264

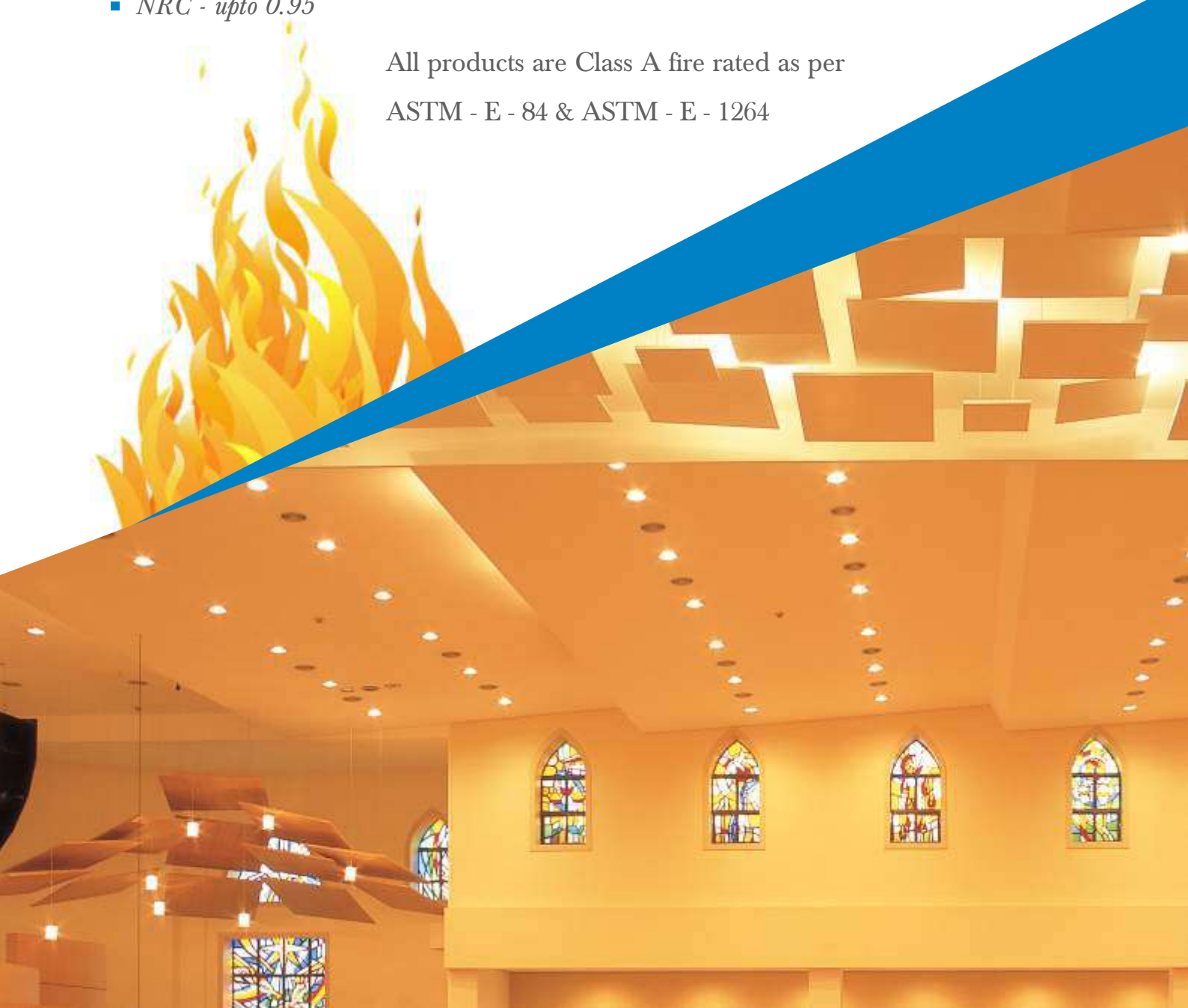

TURCOCORE FELTS ACOUSTICAL SYSTEMS

Turkish Turcocore Felt are large sheets of PET. The panels can be used in different spaces. It can be used on walls and ceilings. Turkish Turcocore Felt comes in multiple thicknesses ranging from 1mm to 6mm. These come in wide variety of colors which are standard and can be customized to a requirement. These are available in a width of 1.00 metre and 1.22 metre.

Turkish Turcocore Felt offers incredible sound acoustics as well as great aesthetics.

SPECIFICATION

- Thickness: 1mm to 6mm
- Maximum Dimension: W-1.00m & 1.22m, L-10.00m to 50.00m rolls
- Density Kg/ m² (+/- 10%): 350 gms to 900 gms.
- 100% Polyester Core
- Warranty: Warranted against workmanship and manufacturing defects for 2 years from date of purchase
- Fire Rating: Class 'B' as per ASTM E - 84 Tunnel Test
- Mounting Method: Glued to the wall using adhesive.

TURCOCORE FELT COLORS



TREC 05 Saffron



TREC 07 Arctic White



TREC 08 Fiery Red



TREC 11 Silver Grey



TREC 13 Black



TREC 19 Indigo



TREC 24 Cherry



TREC 25 China Sea



TREC 28 Sun



TREC 35 Caramel



TREC 37 Gungrey



TREC 39 Coffee



TREC 41 Cinnamon



TREC 43 Apple Green



TREC 44 Shimmer



TREC 46 Orange



TREC 49 Purple



TREC 51 Emerald



TREC 71 Peacock
Blue



TREC 71 Pulp Pink

DIVY MGO Boards

Turkish Magnesium oxide boards are made up of Magnesium Oxide, Magnesium Chloride, Fiberglass Mesh, Wood Dust etc. These boards are waterproof, fireproof, sound insulation boards. These boards have wide scope of application and can replace the wooden boards or gypsum boards. Turkish DIVY Mgo Boards are majorly applied in the indoor partition wall and ceiling. The exterior grade can also be used externally. These are also used in furnitures, fireproof doors, soundproof doors and ventilation pipes.

SPECIFICATION

- Thickness: 3mm to 20mm
- Standard Size: 1220mmX2440mm, 1220mmX3000mm
- Color: White, Grey

ADVANTAGES

- Free of asbestos, so no emission of poisonous gases in case of fire.
- High heat insulation resulting in saving of heat and cold energy.
- High Sound Insulation ensuring peaceful and quiet environment.
- Water and Moisture Resistant resulting in protection against bacteria, mold etc.
- Light in weight and high strength resulting in fast construction and high strength.



Grey



White

MgO Sound Insulation Board

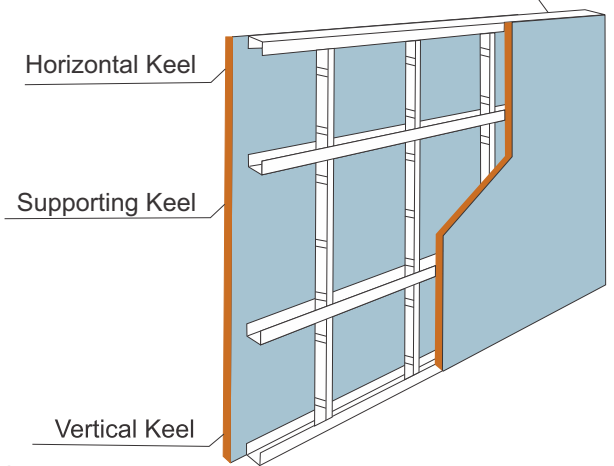

Installation for Wall

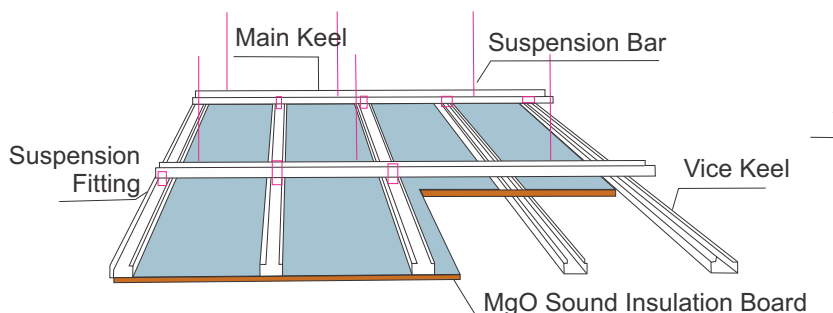

Installation for Ceiling

BLOCK *Flexible Mass Vinyl*

TURKISH BLOCK-MV

These are flexible mass loaded Vinyl used for reducing sound transmission through walls and providing noise isolation from unwanted sources.

- *Material: Mass Loaded Vinyl*
- *Finish: Smooth Finish*
- *Max. dimensions: Length-10/15/20 m,
Thickness-1/1.5/2/3mm
Width-1 / 1.22 / 2mm*
- *Density: 1900 kgs / m³*
- *Dimension Stability: < 0.4%*
- *Flexibility 10mm Mandrel Test: Pass*
- *Flame Spread: Class 1*
- *Installation: Material can be glued, nailed, stapled, screwed and can be reinforced and hung like a curtain.*



TURKISH BLOCK-ED

These are EPDM based flexible surface used for reducing sound transmission through walls and providing noise isolation from unwanted sources.

- *Max dimensions: L - 10m, W - 1m,*
- *Thickness: 3mm, Area- 10 M²*
- *Sound Block: 27 to 30 db*

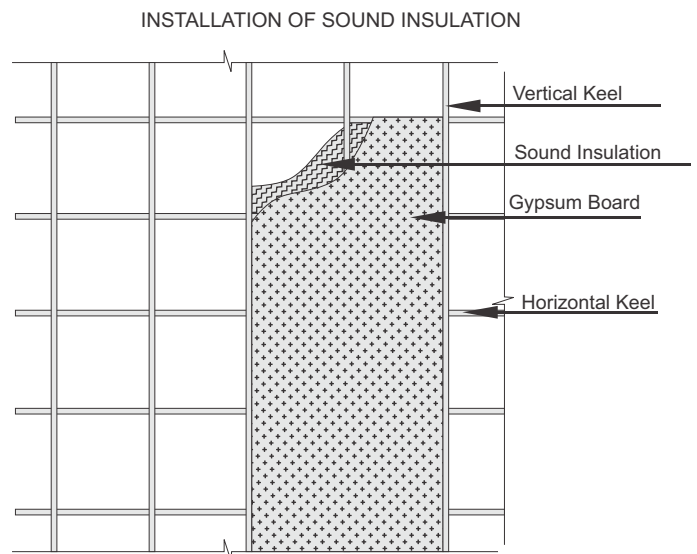

- *Images are indicative*
- *The final product may have cosmetic variations mutually exclusive of the images shown.*
- *Not all constituents shown in the image are part of product package or deliverables*

TURCOFILZ *Hanging Panels*

Turkish Turcofilz Hanging Panels add color, design and modulated visibility to any space. These panels can be used to define space, control light and provide varied degrees of privacy. Available in multiple colors, these hanging panels are compatible with hanging panel track or hanging frame. These panels are ideal choice as hanging panels due to its softness, thickness and free hanging system without any backing and additional support. This enables a modern screening system.

SPECIFICATION

- Width: 1000mm to 1220mm.
- Material: Composite Fibres.
- Thickness: 5mm, 7mm, & Customized Thickness.
- Colors: Wide choice of colors.
- Height: Can be customized to requirement.
- Naturally repels Soiling and Moisture
- Thermal and Acoustic insulating properties.

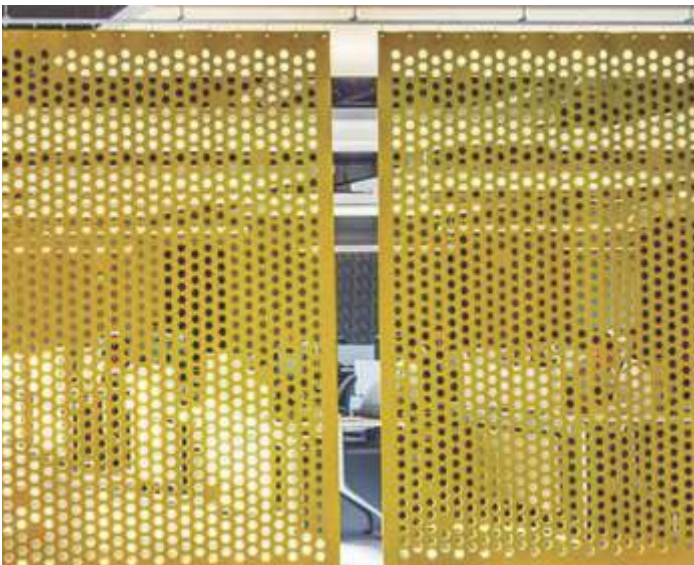

TURKISH ACOUSTIC

Acoustical Systems

APS
TURCOCORE
TURCOWOOD
FILZ
3D

Applications

EDUCATION

- Class Rooms
- Lecture Halls
- Libraries
- Multipurpose Halls
- Gymnasiums
- Aquatic Centers
- Music Rooms
- Prayer Rooms
- Dormitories
- Corridors
- Entertainment Rooms
- Halls
- Children Play Areas



BUSINESS & CORPORATE

- Board Rooms
- Conference Rooms
- Lobbies
- Corridors
- Cabins
- Partitions
- Reception Desks
- Ceilings
- Work Stations, Etc.

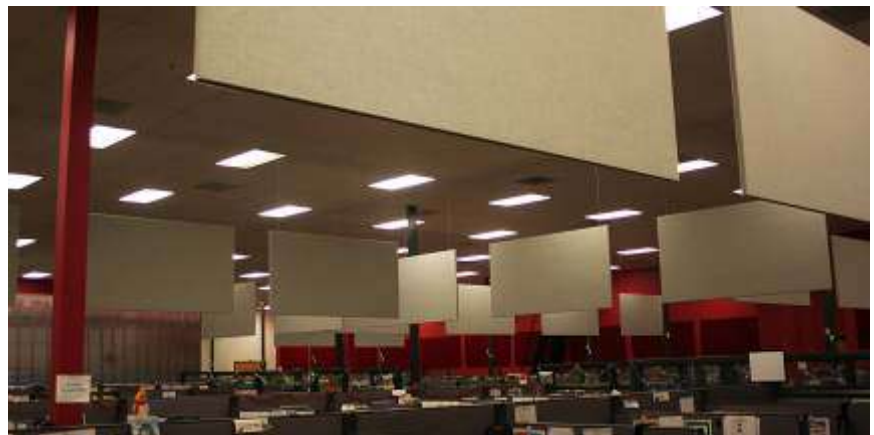

RESIDENTIAL

- Small Home Offices
- Bedrooms
- Home Theatres
- Drawing Rooms
- Dining Room, etc.



TURKISH ACOUSTIC

HOSPITALITY

- Lobbies
- Reception Desks
- Waiting Areas
- Meeting Rooms
- Conference Halls
- Guest Rooms
- Saloons
- Dining Areas
- Party Halls, etc.



THEATRES & AUDITORIUMS

- Multiplex and
- Single Theaters
- Large Auditorium
- Marriage Halls
- Studios
- Home Theatre Systems etc.



HEALTHCARE

- Patient Waiting Halls/ Rooms
- ICU
- Casualty Rooms
- Wards/ Walk Way/ Corridors
- Operation Theatres
- Reception Areas



RECREATION CLUBS & SPORTS ARENAS

- High Noise Ball Game Areas Like Basketball, Volleyball, etc.
- Table Tennis, Squash, Badminton, Bridge Rooms, Multi Sport Halls
- Swimming Pools, etc..



Clientele

TURKISH ACOUSTIC

Turgut Reis Mah. Nejat Sk. No:3/A İstanbul/Sultanbeyli 34920

P: +90 (216) 592 49 66 M: +90 533 792 49 66

E: destek@turkishacoustic.com.tr

www.turkishacoustic.com.tr